

120V N-Channel SGT Power MOSFET

MAIN CHARACTERISTICS

I_D	40A
V_{DS}	120V
R_{DS(on)-typ(@V_{GS}=10V)}	< 13mΩ (Typ: 10mΩ)

FEATURES

- ↓ Low Gate Charge Minimize Switching Loss
- ↓ Fast Recovery Body Diode
- ↓ **YFW-SGT technology**

APPLICATION

- ↓ DC-DC Converters
- ↓ Ideal for high-frequency switching and synchronous

MECHANICAL DATA

- ↓ Case: TO-220C/AC TO-263C/ASC
- ↓ Mounting Position: Any

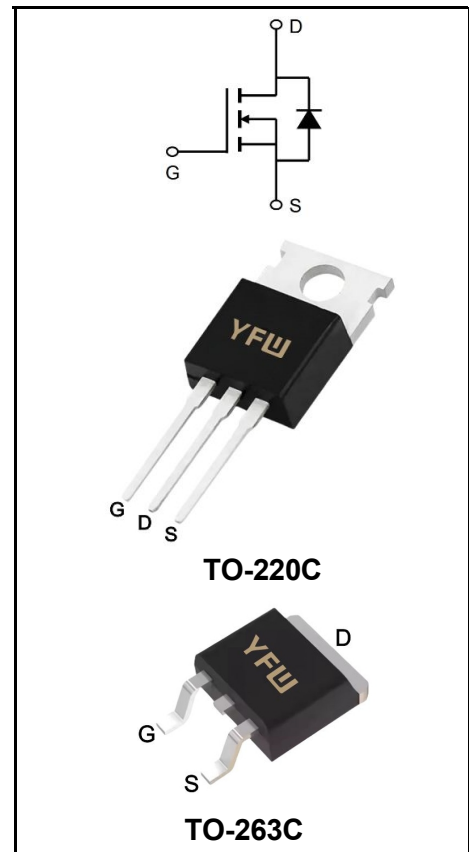

Maximum Ratings at T_c=25°C unless otherwise specified

Characteristics	Symbols	Value	Units
Drain-Source Voltage	V_{DS}	120	V
Gate - Source Voltage	V_{GS}	±20	V
Continuous drain current	I_D	40	A
Pulsed Drain Current (Note1)	I_{DM}	160	A
Power Dissipation	P_D	85	W
Single Pulse Avalanche Energy (Note1)	E_{AS}	180	mJ
Operating Temperature Range	T_J	150	°C
Storage Temperature Range	T_{STG}	-55 to +150	°C
Thermal Resistance Junction-Case	R_{θJC}	1.47	°C/W
Thermal Resistance, Junction--Ambient	R_{θJA}	62	°C/W

Note1: Pulse test: 300 μs pulse width, 2 % duty cycle

Maximum Ratings at Tc=25°C unless otherwise specified

Characteristics	Test Condition	Symbols	Min	Typ	Max	Units
Drain-Source Breakdown Voltage	$V_{GS}=0V, I_D=250\mu A$	BV_{DSS}	120	-	-	V
Drain-Source Leakage Current	$V_{DS}=120V, V_{GS}=0V$	I_{DSS}	-	-	1	μA
Gate-Source Leakage Current	$V_{GS} = \pm 20 V, V_{DS} = 0 V$	I_{GSS}	-	-	± 100	nA
Gate-Source Threshold Voltage	$V_{DS}=V_{GS}, I_D=250\mu A$	$V_{GS(th)}$	1.1	-	2.5	V
Drain-source on-state resistance	$V_{GS}=10V, I_D=20A$	$R_{DS(on)}$	-	10	13	m Ω
	$V_{GS}=4.5V, I_D=20A$		-	14	16.5	
Input Capacitance	$V_{GS}=0V$ $V_{DS}=60V$ $f=1MHz$	C_{iss}	-	1431	-	pF
Output Capacitance		C_{oss}	-	313	-	
Reverse Transfer Capacitance		C_{rss}	-	31	-	
Turn-on delay time(Note2)	$V_{DD}=60V$ $V_{GS}=10V$ $R_G=2.2\Omega$ $I_D=20 A$	$t_{d(on)}$	-	14	-	ns
Rise Time(Note2)		T_r	-	5	-	
Turn-Off Delay Time(Note2)		$t_{d(OFF)}$	-	30	-	
Fall Time(Note2)		t_f	-	6	-	
Total Gate Charge(Note2)	$I_D=20A$ $V_{DS}=60V$ $V_{GS}=10V$	Q_g	-	21	-	nC
Gate-Source Charge(Note2)		Q_{gs}	-	5	-	
Gate-Drain Charge(Note2)		Q_{gd}	-	3	-	
Maximun Body-Diode Continuous Current		I_S	-	-	40	A
Maximun Body-Diode Pulsed Current(Note2)		I_{SM}	-	-	160	A
Drain-Source Diode Forward Voltage	$I_S=30A, V_{GS}=0 V T_J=25^\circ C$	V_{SD}	-	-	1.2	V
Reverse Recovery Time(Note2)	$I_{SD} = 20 A, V_{GS} = 0 V,$ $dIF / dt = 100 A/\mu s$	t_{rr}	-	57	-	ns
Reverse Recovery Charge(Note2)		Q_{rr}	-	59	-	nC

Note2:Pulse test: 300 μs pulse width, 2 % duty cycle

Ratings and Characteristic Curves

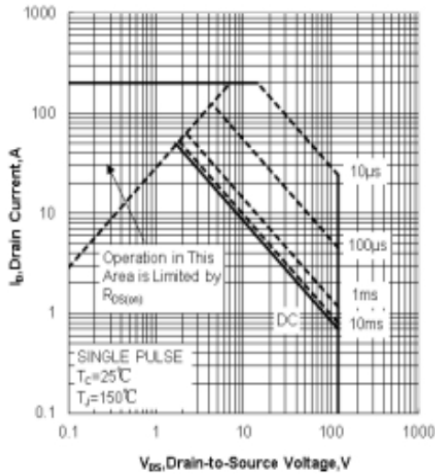

Figure1. Maximum Forward Bias Safe Operating Area

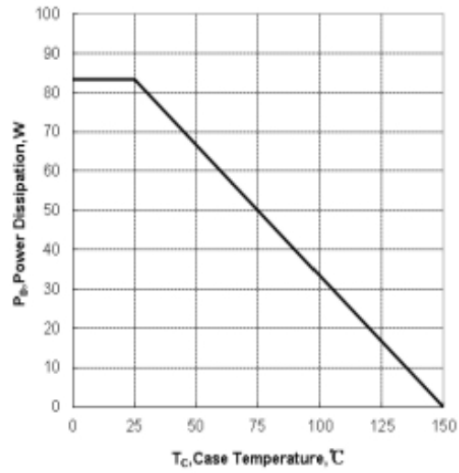

Figure2. Maximum Power Dissipation vs Case Temperature

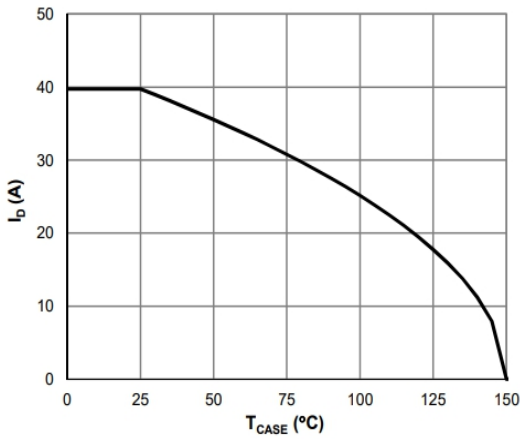

Figure3. Maximum Continuous Drain Current vs Case Temperature

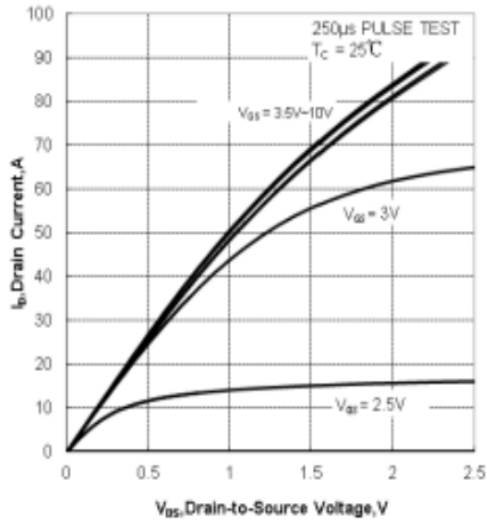

Figure 4. Typical Output Characteristics

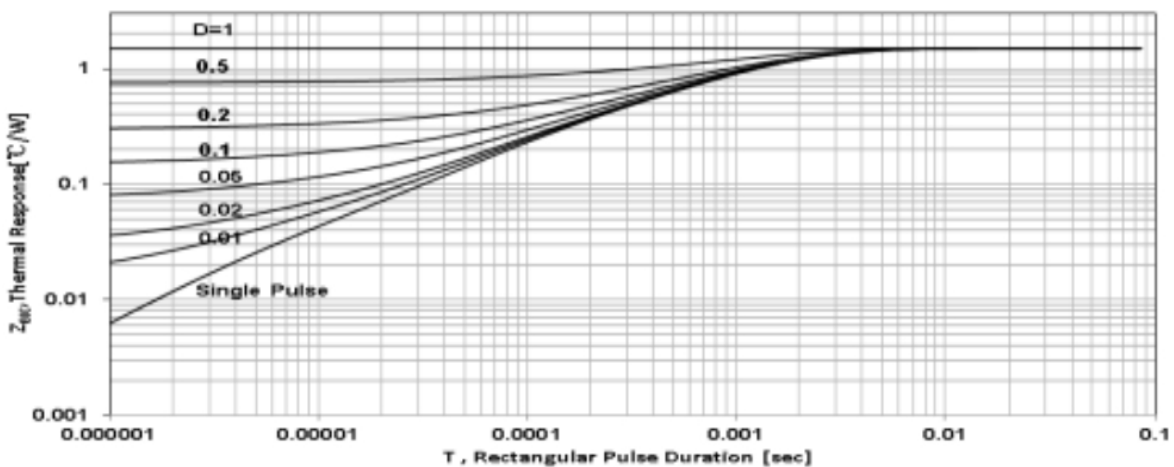

Figure5. Maximum Effective Transient Thermal Impedance, Junction-to-Case

Ratings and Characteristic Curves

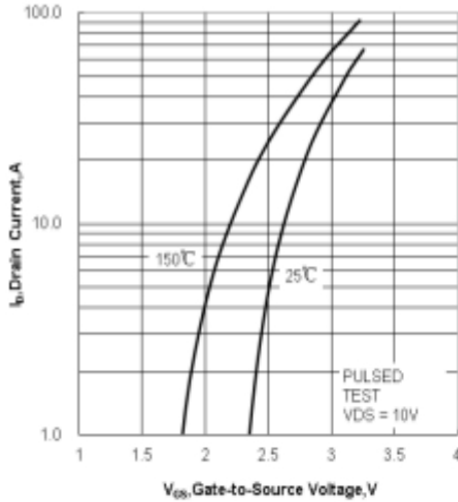

Figure 6. Typical Transfer Characteristics

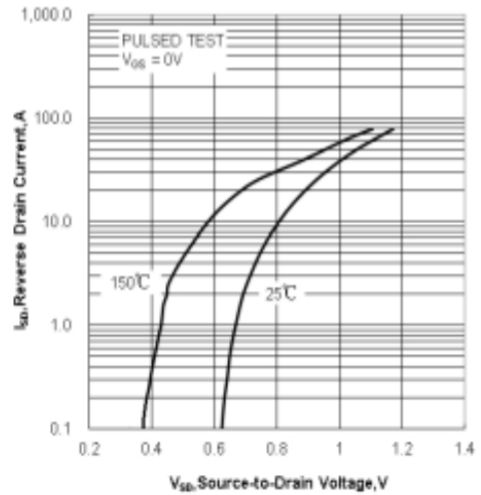

Figure 7. Typical Body Diode Transfer Characteristics

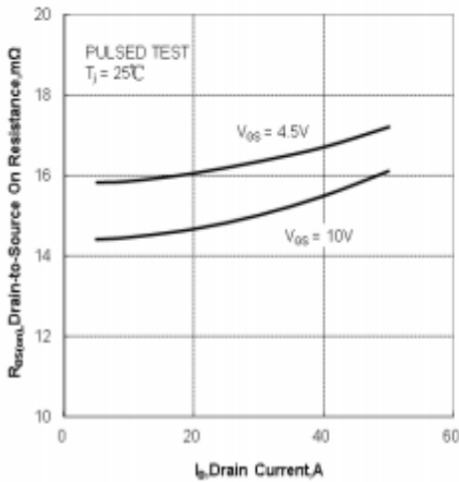

Figure 8. Drain-to-Source On Resistance vs Drain Current

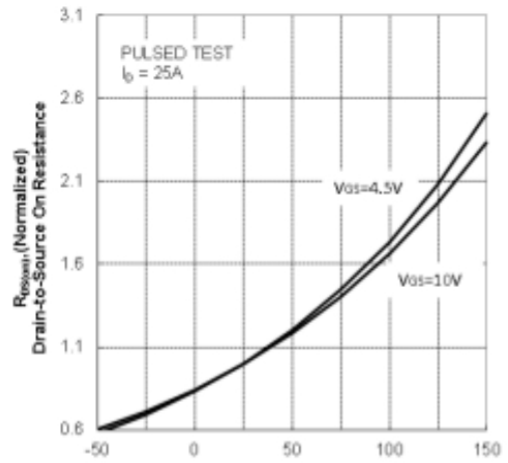

Figure 9. Normalized on Resistance vs Junction Temperature

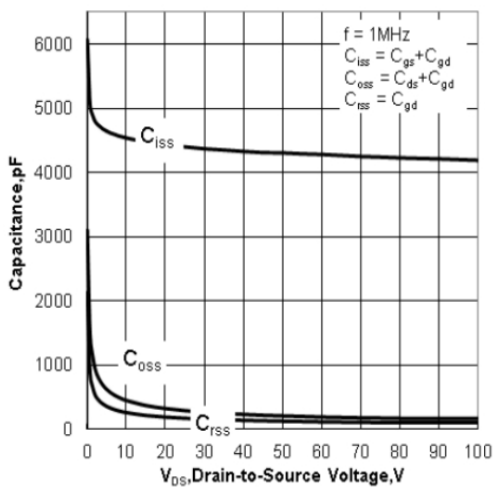

Figure 10. Capacitance Characteristics

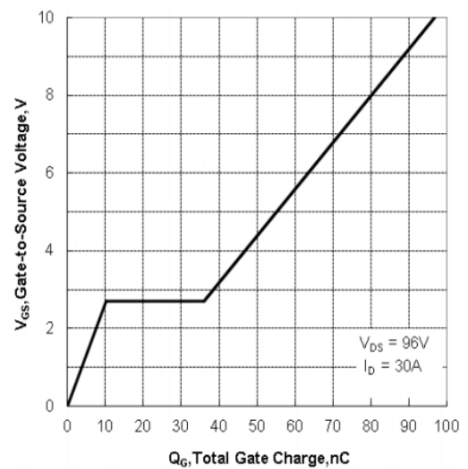
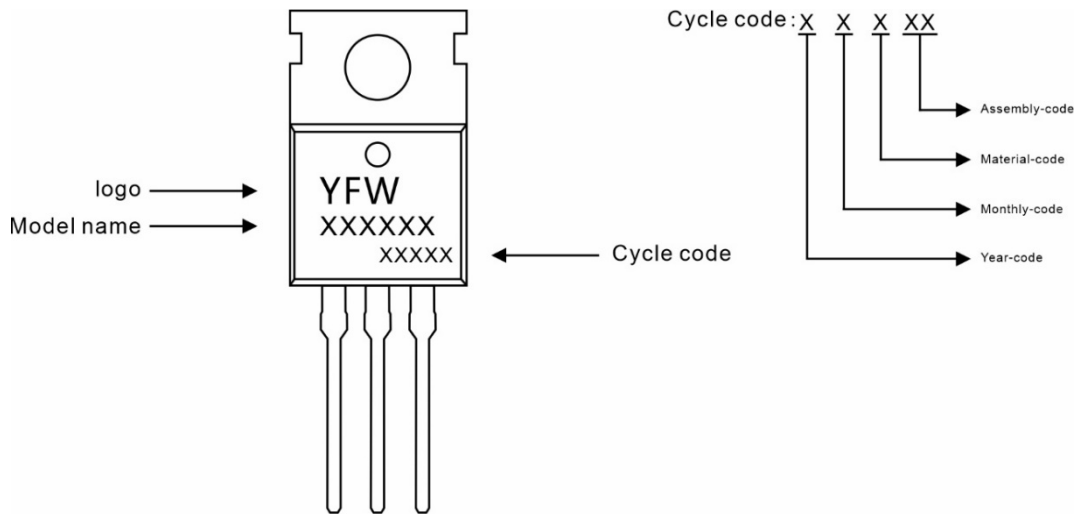

Figure 11. Typical Gate Charge vs Gate to Source Voltage

Marking Diagram



Ordering information

Model name	Package	Unit Weight	Base Quantity	Packing Quantity
YFWG40N12AC	TO-220C	0.07oz(1.96g)	50pcs/tube	1000PCS/Box 5000PCS/Carton

Package Dimensions

TO-220C

Dim	Millimeter		Inches	
	Min.	Max.	Min.	Max.
A	4.34	4.67	0.171	0.184
A1	2.52	2.82	0.099	0.111
b	0.71	0.91	0.028	0.036
b1	1.17	1.37	0.046	0.054
c	0.30	0.50	0.012	0.020
c1	1.17	1.37	0.046	0.054
D	9.90	10.20	0.390	0.402
E	8.50	8.90	0.335	0.350
E1	12.00	12.50	0.472	0.492
e	2.44	2.64	0.096	0.104
e1	4.88	5.28	0.192	0.208
F	2.60	2.80	0.102	0.110
L	13.20	13.80	0.520	0.543
L1	3.80	4.20	0.150	0.165
Φ	3.60	3.96	0.142	0.156

Marking Diagram

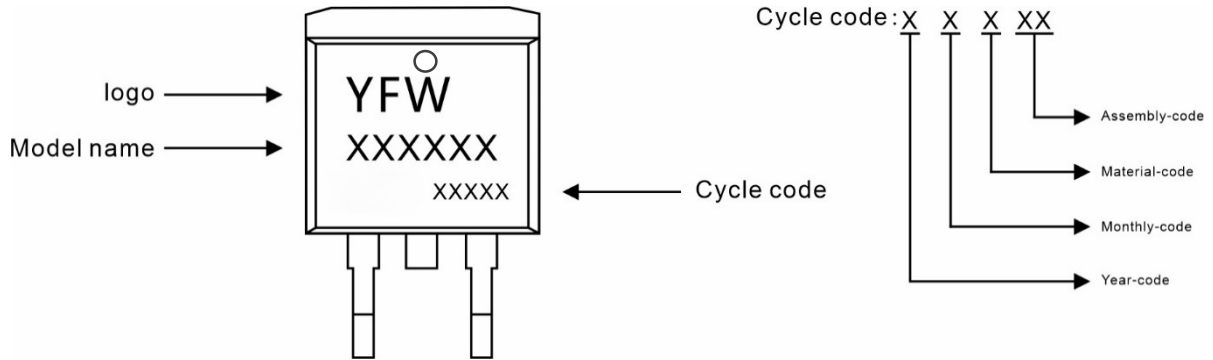

Ordering information

Model name	Package	Unit Weight	Base Quantity	Packing Quantity
YFWG40N12ASC	TO-263C	0.04oz(1.16g)	800pcs/reel	1600pcs/box 8000pcs/Cartron

Package Dimensions

TO-263C

Dim	Millimeter		Inches	
	Min.	Max.	Min.	Max.
A	4.30	4.70	0.169	0.185
A1	0.00	0.15	0.000	0.006
A2	4.30	4.55	0.169	0.179
B	1.10	1.50	0.043	0.059
b	0.70	0.90	0.028	0.035
b1	1.20	1.50	0.047	0.059
c	0.30	0.60	0.012	0.024
c1	1.17	1.37	0.046	0.054
D	9.90	10.20	0.390	0.402
E	8.50	8.90	0.335	0.350
e	2.44	2.64	0.096	0.104
e1	4.88	5.28	0.192	0.208
L	15.00	15.30	0.591	0.602
L1	5.20	5.40	0.205	0.213
L2	2.40	2.60	0.094	0.102
L3	1.60	1.80	0.063	0.071

Disclaimer

The information presented in this document is for reference only. Guangdong Youfeng Microelectronics Co.,Ltd. reserves the right to make changes without notice for the specification of the products displayed herein to improve reliability, function or design or otherwise. The product listed herein is designed to be used with ordinary electronic equipment or devices, and not designed to be used with equipment or devices which require high level of reliability and the malfunction of which would directly endanger human life (such as medical instruments, transportation equipment, aerospace machinery, nuclear-reactor controllers, fuel controllers and other safety devices), YFW or anyone on its behalf, assumes no responsibility or liability for any damages resulting from such improper use of sale. This publication supersedes & replaces all information previously supplied. For additional information, please visit our website <https://www.yfwdiode.com>, or consult YFW sales office for further assistance.