

200V N-CHANNEL ENHANCEMENT MODE MOSFET

MAIN CHARACTERISTICS

I_D	90A
V_{DS}	200V
R_{DS(on)-typ(@V_{GS}=10V)}	<24mΩ(Typ:21mΩ)

FEATURES

Adopt advanced trench technology to provide excellent Battery protection or in other Switching application.

APPLICATIONS

- ◆ Motor control and drive
- ◆ Battery management
- ◆ UPS (Uninterruptible Power Supplies)

MECHANICAL DATA

- ◆ Case: TO-220C/AC TO-263C/ASC
- ◆ Molded Plastic: UL Flammability Classification Rating 94V-0
- ◆ Lead free in compliance with EU RoHS 2011/65/EU directive
- ◆ Solder bath temperature 275°C maximum,10s per JESD 22-B106

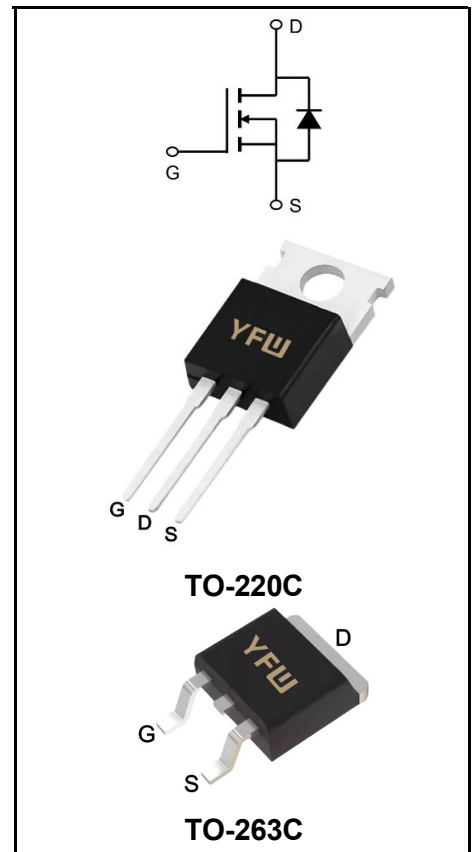

Maximum Ratings at T_c=25°C unless otherwise specified

Characteristics	Symbol	Value	Unit
Drain-Source Voltage	V_{DS}	200	V
Gate-Source Voltage	V_{GS}	±20	V
Continue Drain Current	I_D	90	A
Pulsed Drain Current (Note1)	I_{DM}	360	A
Power Dissipation	P_D	132	W
Single Pulse Avalanche Energy (Note1)	E_{AS}	968	mJ
Operating Temperature Range	T_J	150	°C
Storage Temperature Range	T_{STG}	-55 to +150	°C
Thermal Resistance, Junction to Case	R_{θJC}	0.95	°C/W
Thermal Resistance, Junction to Ambient	R_{θJA}	62.5	°C/W

Note1:Pulse test: 300 μs pulse width, 2 % duty cycle

Note2:Limited by T_{Jmax} , starting T_J=25°C, L = 1mH, V_{DS} =50V.,V_{GS} =10V

Electrical Characteristics at Tc=25°C unless otherwise specified

Characteristics	Test Condition	Symbol	Min	Typ	Max	Unit
Drain-Source Breakdown Voltage	$V_{GS} = 0\text{ V}, I_D = 250\mu\text{A}$	BV_{DSS}	200	-	-	V
Drain-Source Leakage Current	$V_{DS} = 200\text{ V}, V_{GS} = 0\text{ V}$	I_{DSS}	-	-	1	μA
Gate Leakage Current	$V_{GS} = \pm 20\text{ V}, V_{DS} = 0\text{ V}$	I_{GSS}	-	-	± 100	nA
Gate-Source Threshold Voltage	$V_{DS} = V_{GS}, I_D = 250\mu\text{A}$	$V_{GS(th)}$	3	-	5	V
Drain-Source On-State Resistance	$V_{GS} = 10\text{ V}, I_D = 30\text{ A}$	$R_{DS(on)}$	-	21	24	mΩ
Forward Transconductance	$V_{DS} = 5\text{ V}, I_D = 40\text{ A}$	g_{fs}	-	65	-	S
Input Capacitance	$V_{GS} = 0\text{ V}$ $V_{DS} = 25\text{ V}$ $f = 1\text{ MHz}$	C_{iss}	-	6500	-	pF
Output Capacitance		C_{oss}	-	500	-	
Reverse Transfer Capacitance		C_{rss}	-	210	-	
Turn-on Delay Time(Note2)	$V_{GS}=10\text{V}$ $V_{DD} =50\text{V}$ $R_G= 2.5\ \Omega$ $I_D=40\text{A}$	$t_{d(ON)}$	-	45	-	ns
Rise Time(Note2)		t_r	-	70	-	
Turn-Off Delay Time(Note2)		$t_{d(OFF)}$	-	110	-	
Fall Time(Note2)		t_f	-	90	-	
Total Gate Charge(Note2)	$V_{DS}=100\text{V}$ $V_{GS}=10\text{V}$ $I_D=40\text{A}$	Q_G	-	85	-	nC
Gate to Source Charge(Note2)		Q_{GS}	-	15	-	
Gate to Drain Charge(Note2)		Q_{GD}	-	25	-	
Maximun Body-Diode Continuous Current		I_S	-	-	90	A
Maximun Body-Diode Pulsed Current(Note2)		I_{SM}	-	-	360	A
Drain-Source Diode Forward Voltage	$V_{GS}=0\text{V}, I_S=30\text{A}, T_J=25^\circ\text{C}$	V_{SD}	-	-	1.2	V
Reverse Recovery Time(Note2)	$T_J = 25^\circ\text{C}, I_F = 30\text{A}$ $di / dt = 100\text{A}/\mu\text{s}$	t_{rr}	-	110	-	ns
Reverse Recovery Charge(Note2)		Q_{rr}	-	0.55	-	nC

 Note2:Pulse test: 300 μs pulse width, 2 % duty cycle

RATINGS AND CHARACTERISTIC CURVES

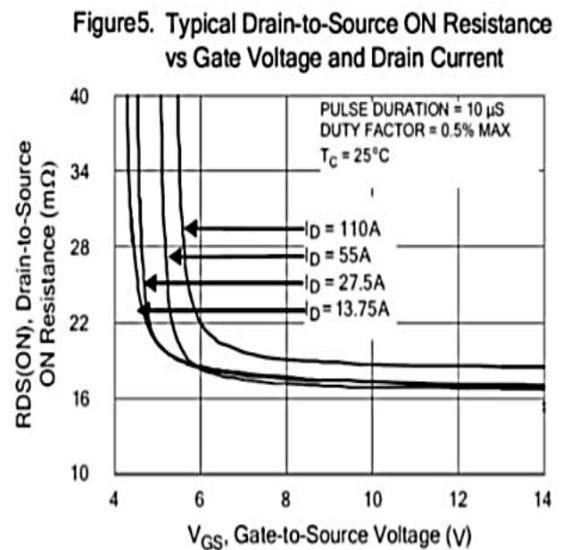
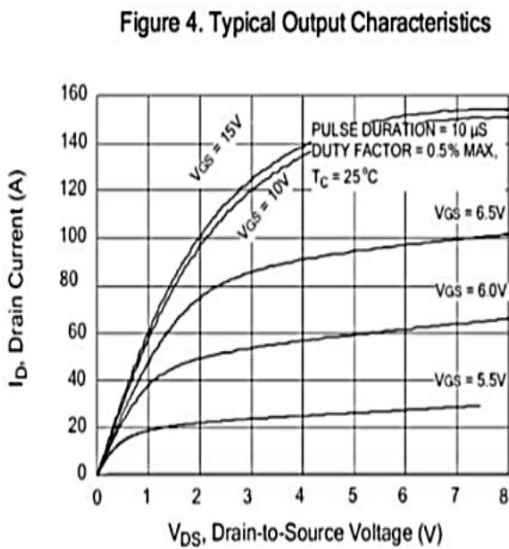
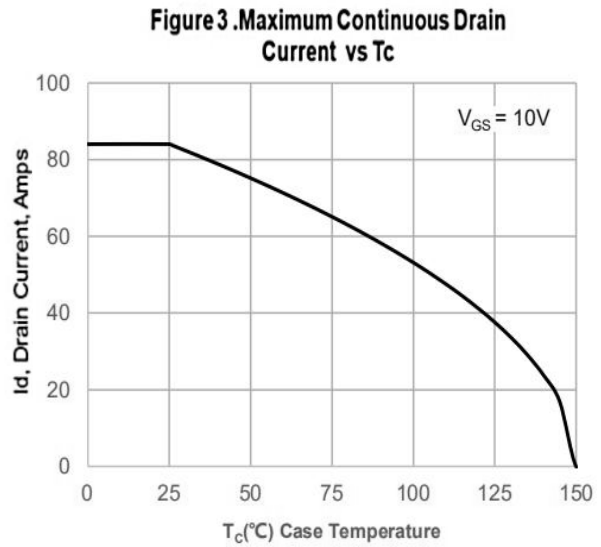
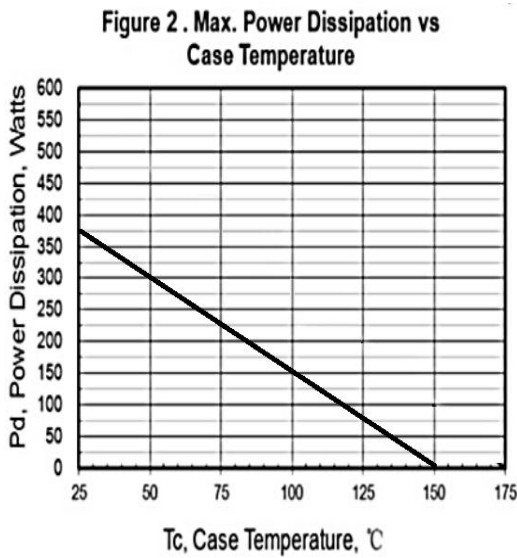
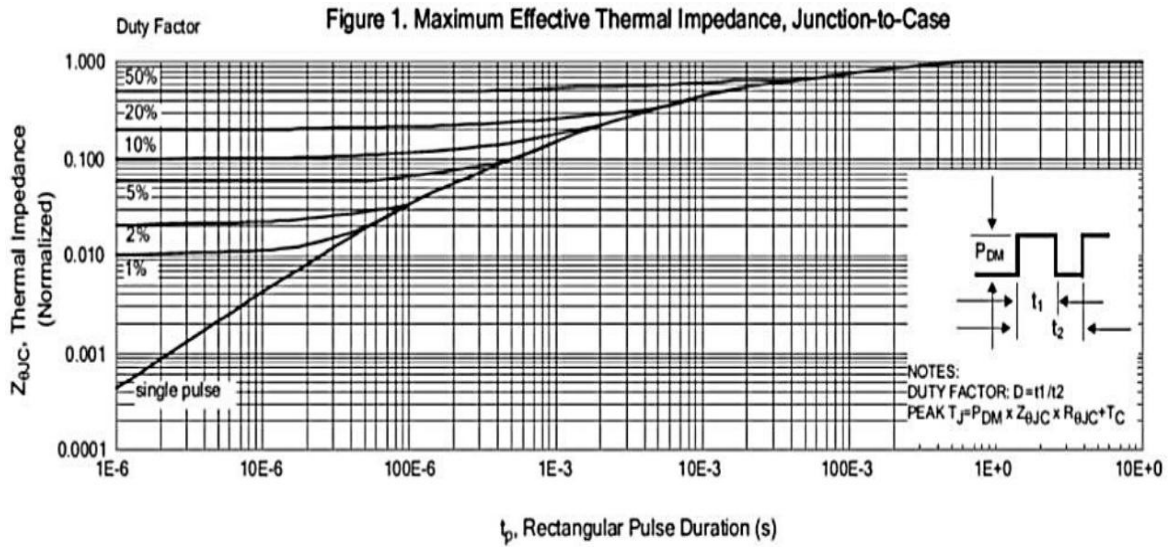

RATINGS AND CHARACTERISTIC CURVES

Figure 6. Peak Current Capability

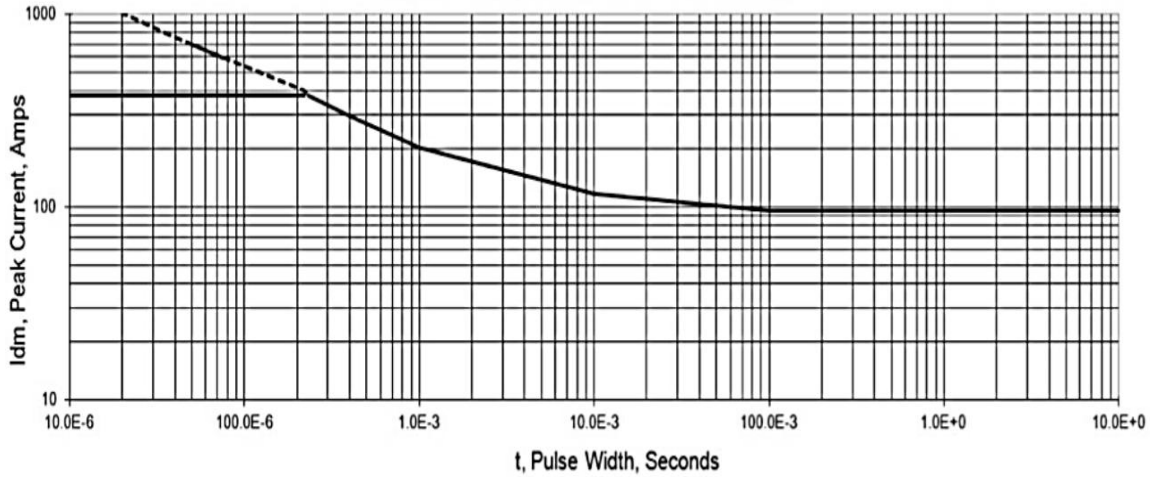

Figure 7. Typical Transfer Characteristics

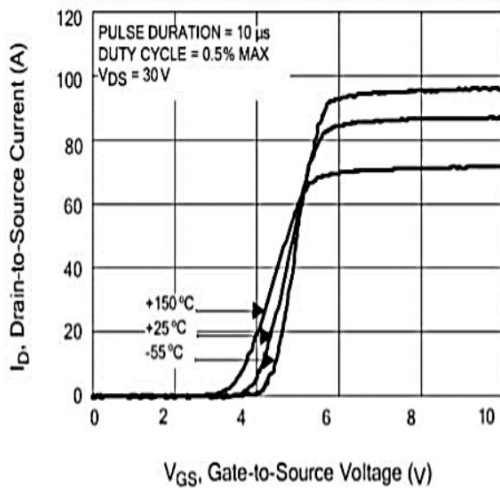

Figure 9. Typical Drain-to-Source ON Resistance vs Drain Current

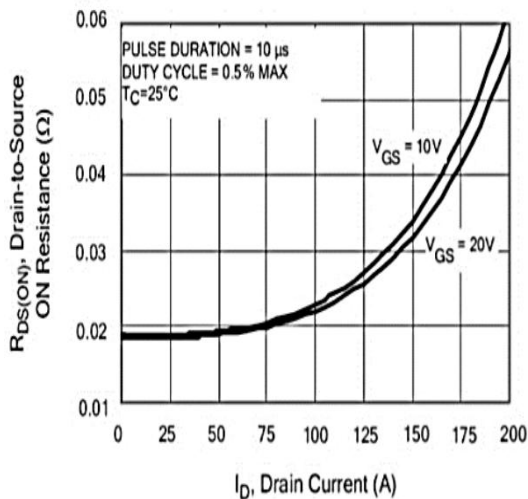

Figure 8. Unclamped Inductive Switching Capability

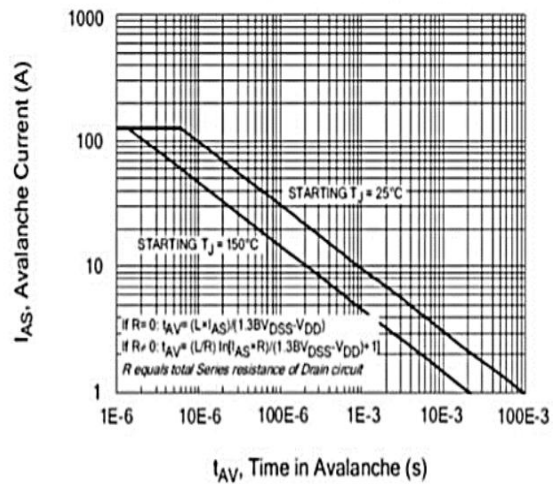
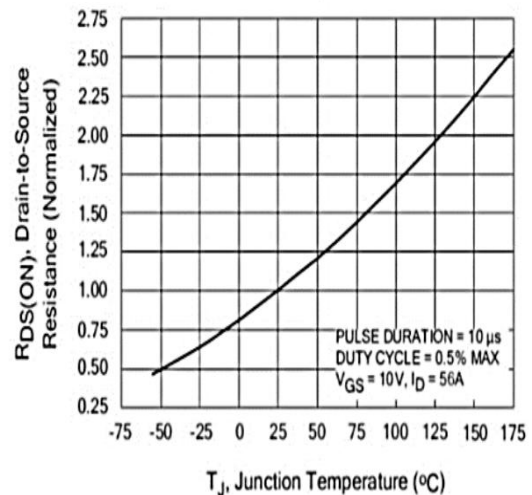

Figure 10. Typical Drain-to-Source ON Resistance vs Junction Temperature



RATINGS AND CHARACTERISTIC CURVES

Figure 11. Typical Breakdown Voltage vs Junction Temperature

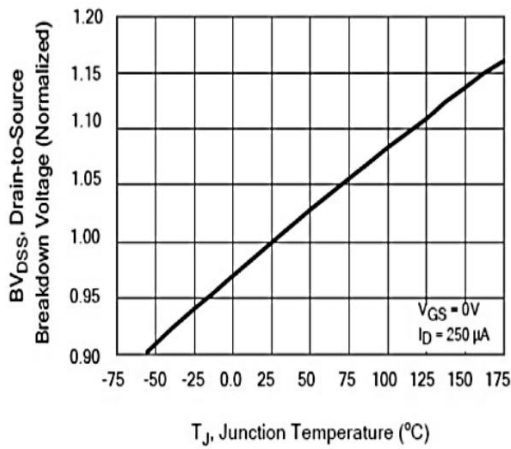

Figure 12. Typical Threshold Voltage vs Junction Temperature

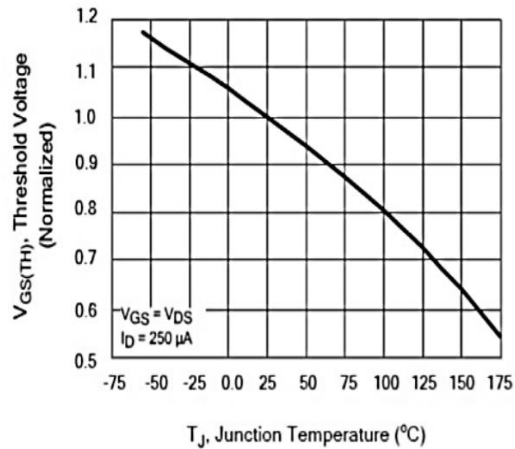

Figure 13. Maximum Safe Operating Area

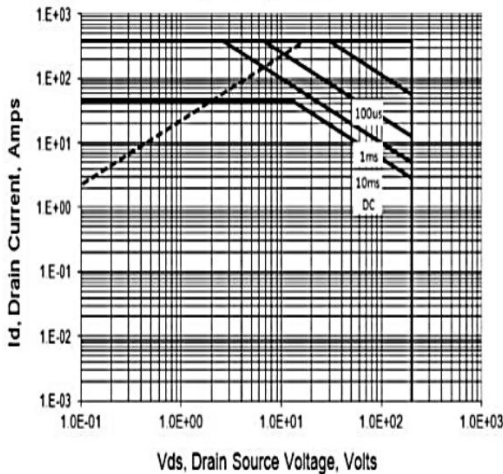

Figure 14. Capacitance vs Vds

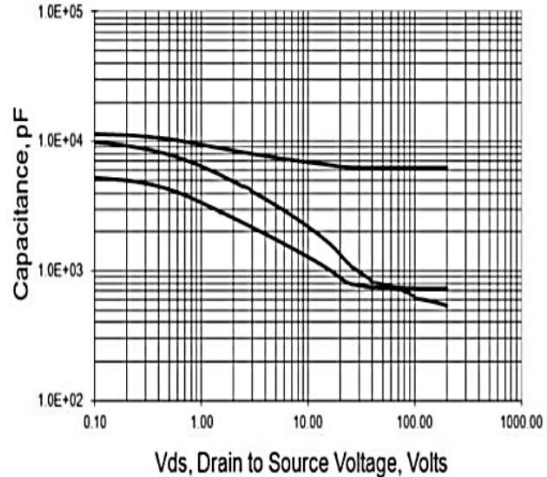

Figure 15. Typical Gate Charge

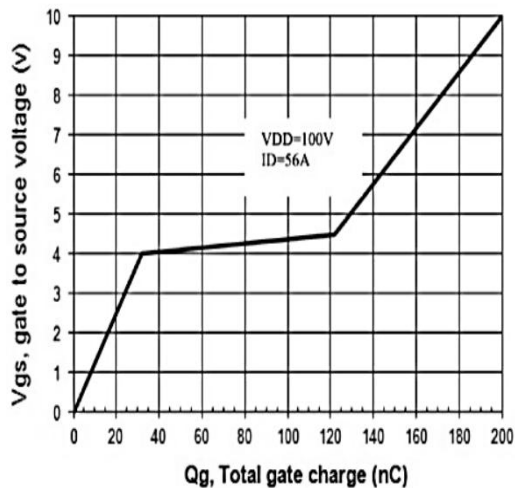
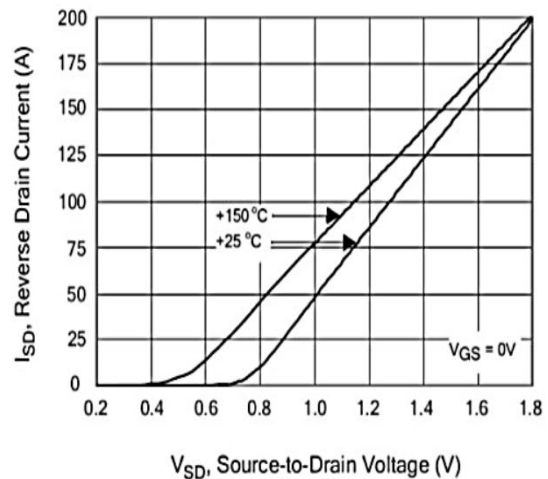
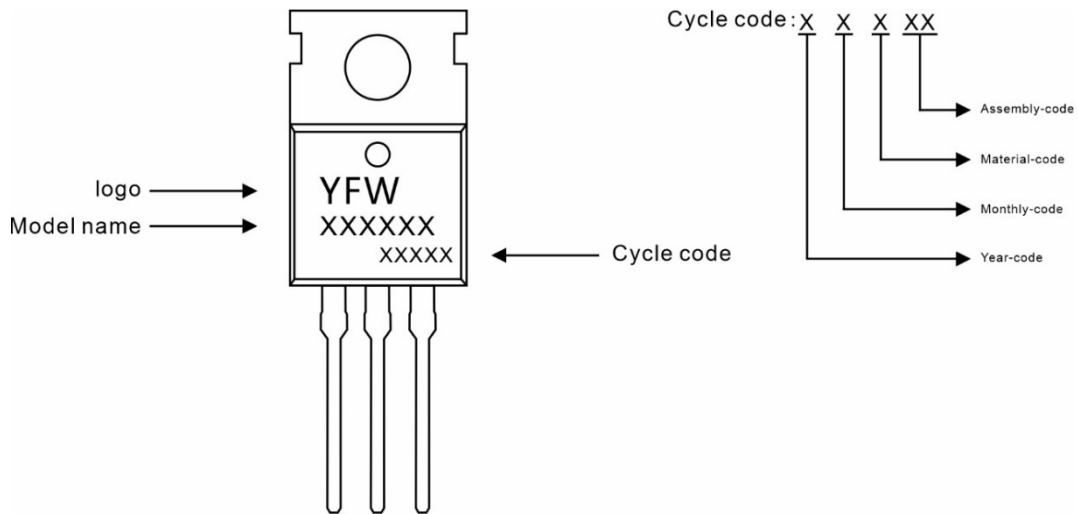

Figure 16. Typical Body Diode Transfer Characteristics



Marking Diagram



Ordering information

Model name	Package	Unit Weight	Base Quantity	Packing Quantity
YFW90N20HAC	TO-220C	0.07oz(1.96g)	50pcs/tube	1000PCS/Box 5000PCS/Carton

Package Dimensions

TO-220C

Dim	Millimeter		Inches	
	Min.	Max.	Min.	Max.
A	4.34	4.67	0.171	0.184
A1	2.52	2.82	0.099	0.111
b	0.71	0.91	0.028	0.036
b1	1.17	1.37	0.046	0.054
c	0.30	0.50	0.012	0.020
c1	1.17	1.37	0.046	0.054
D	9.90	10.20	0.390	0.402
E	8.50	8.90	0.335	0.350
E1	12.00	12.50	0.472	0.492
e	2.44	2.64	0.096	0.104
e1	4.88	5.28	0.192	0.208
F	2.60	2.80	0.102	0.110
L	13.20	13.80	0.520	0.543
L1	3.80	4.20	0.150	0.165
Φ	3.60	3.96	0.142	0.156

Marking Diagram

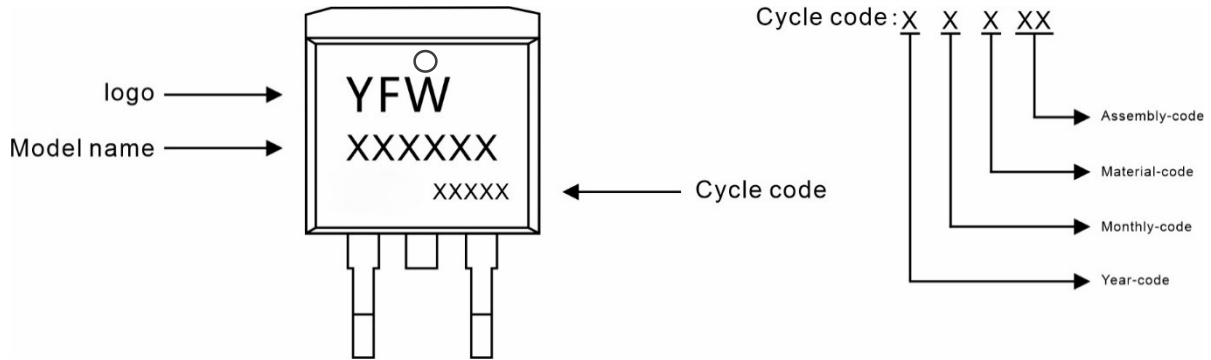

Ordering information

Model name	Package	Unit Weight	Base Quantity	Packing Quantity
YFW90N20HASC	TO-263C	0.04oz(1.16g)	800pcs/reel	1600pcs/box 8000pcs/Carton

Package Dimensions

TO-263C

Dim	Millimeter		Inches	
	Min.	Max.	Min.	Max.
A	4.30	4.70	0.169	0.185
A1	0.00	0.15	0.000	0.006
A2	4.30	4.55	0.169	0.179
B	1.10	1.50	0.043	0.059
b	0.70	0.90	0.028	0.035
b1	1.20	1.50	0.047	0.059
c	0.30	0.60	0.012	0.024
c1	1.17	1.37	0.046	0.054
D	9.90	10.20	0.390	0.402
E	8.50	8.90	0.335	0.350
e	2.44	2.64	0.096	0.104
e1	4.88	5.28	0.192	0.208
L	15.00	15.30	0.591	0.602
L1	5.20	5.40	0.205	0.213
L2	2.40	2.60	0.094	0.102
L3	1.60	1.80	0.063	0.071

Disclaimer

The information presented in this document is for reference only. GuangDong Youfeng Microelectronics Co.,Ltd. reserves the right to make changes without notice for the specification of the products displayed herein to improve reliability, function or design or otherwise. The product listed herein is designed to be used with ordinary electronic equipment or devices, and not designed to be used with equipment or devices which require high level of reliability and the malfunction of with would directly endanger human life (such as medical instruments, transportation equipment, aerospace machinery, nuclear-reactor controllers, fuel controllers and other safety devices),YFW or anyone on its behalf, assumes no responsibility or liability for any damages resulting from such improper use of sale. This publication supersedes & replaces all information previously supplied. For additional information, please visit our website <https://www.yfwdiode.com>, or consult YFW sales office for further assistance.