

-150V P-CHANNEL ENHANCEMENT MODE MOSFET

MAIN CHARACTERISTICS

I_D	-7A
V_{DSS}	-150V
$R_{DS(on)-typ}(@V_{GS}=-10V)$	< 780mΩ (Type:620mΩ)

Application

- ◆ Brushless motor
- ◆ Load switch
- ◆ Uninterruptible power supply

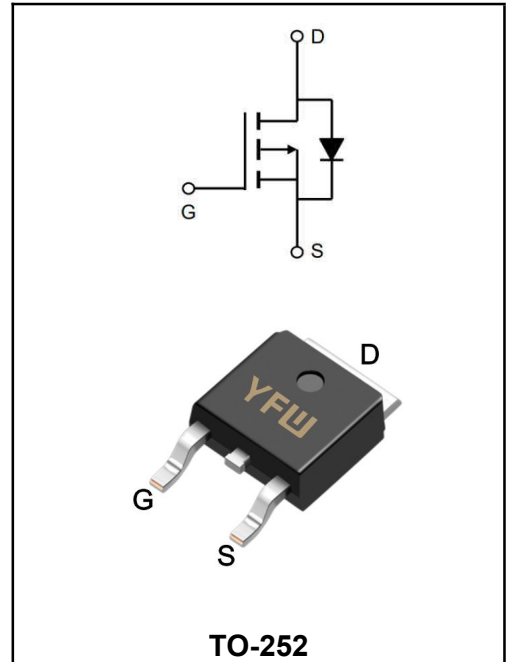

Maximum Ratings at Tc=25°C unless otherwise specified

Characteristics	Symbols	Value	Units
Drain-Source Voltage	V_{DS}	-150	V
Gate - Source Voltage	V_{GS}	±20	V
Continuous Drain Current, $V_{GS} @ -10V^1 @ T_A=25^\circ C$	I_D	-7.0	A
Continuous Drain Current, $V_{GS} @ -10V^1 @ T_A=70^\circ C$	I_D	-4.8	A
Pulsed Drain Current ²	I_{DM}	-28	A
Single Pulse Avalanche Energy ³	E_{AS}	56.5	mJ
Avalanche Current	I_{AS}	5	A
Total Power Dissipation ⁴ @ $T_A=25^\circ C$	P_D	2	W
Storage Temperature Range	T_{STG}	-55 to +150	°C
Operating Junction Temperature Range	T_J	-55 to +150	°C
Thermal Resistance Junction-Ambient ¹	$R_{\theta JA}$	62	°C/W
Thermal Resistance Junction-Case ¹	$R_{\theta JC}$	40	°C/W

Maximum Ratings at Tc=25°C unless otherwise specified

Characteristics	Test Condition	Symbols	Min	Typ	Max	Units
Drain-Source Breakdown Voltage	$V_{GS}=0V, I_D=-250\mu A$	BV_{DSS}	-150	-168	-	V
Static Drain-Source On-Resistance	$V_{GS}=-10V, I_D=-1A$	$R_{DS(ON)}$	-	620	780	mΩ
	$V_{GS}=-6V, I_D=-0.5A$		-	700	980	
Gate -Threshold Voltage	$V_{DS}=V_{GS}, I_D=-250\mu A$	$V_{GS(th)}$	-2.0	-3.0	-4.0	V
Drain -Source Leakage Current	$V_{DS}=120V, V_{GS}=0V, T_J=25^\circ C$	I_{DSS}	-	-	1	μA
	$V_{DS}=120V, V_{GS}=0V, T_J=85^\circ C$		-	-	30	
Gate-Source Leakage Current	$V_{GS}=\pm 20V, V_{DS}=0V$	I_{GSS}	-	-	±100	nA
Gate Resistance	$V_{DS}=0V, V_{GS}=0V, f=1MHz$	R_g	-	12	-	Ω
Total Gate Charge	$V_{DS}=-75V$ $V_{GS}=-10V$ $I_D=-1A$	Q_g	-	10.8	-	nC
Gate-Source Charge		Q_{gs}	-	3.1	-	
Gate-Drain Charge		Q_{gd}	-	2.2	-	
Turn-on delay time	$V_{DD}=-30V$ $V_{GS}=-10V$ $R_G=6\Omega$ $I_D=-1A$	$t_{d(on)}$	-	21	-	nS
Rise Time		T_r	-	16	-	
Turn-Off Delay Time		$t_{d(OFF)}$	-	40	-	
Fall Time		t_f	-	18	-	
Input Capacitance	$V_{DS}=-75V$ $V_{GS}=0V$ $f=1.0MHz$	C_{iss}	-	706	-	pF
Output Capacitance		C_{oss}	-	23	-	
Reverse Transfer Capacitance		C_{rss}	-	13	-	

Note :

- 1、 The data tested by surface mounted on a 1 inch 2 FR-4 board with 2OZ copper.
- 2、 The data tested by pulsed , pulse width $\leq 300\mu s$, duty cycle $\leq 2\%$
- 3、 The EAS data shows Max. rating . The test condition is $V_{DD}=-50V, V_{GS}=-10V, L=0.5mH, I_{AS}=-5A$
- 4、 The power dissipation is limited by 150°C junction temperature
- 5、 The data is theoretically the same as I D and I DM , in real applications , should be limited by total power dissipation.

Ratings and Characteristic Curves

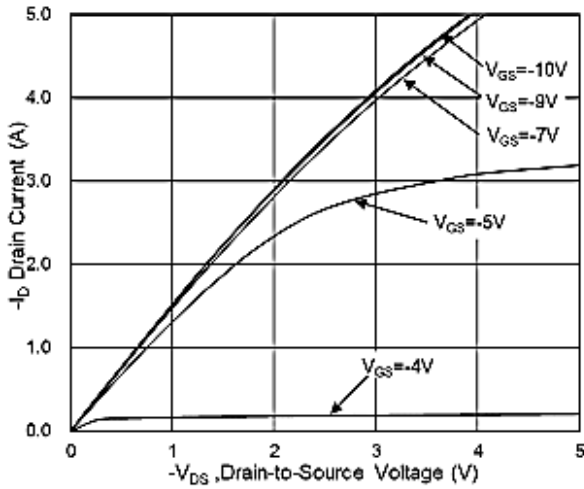

Fig.1 Typical Output Characteristics

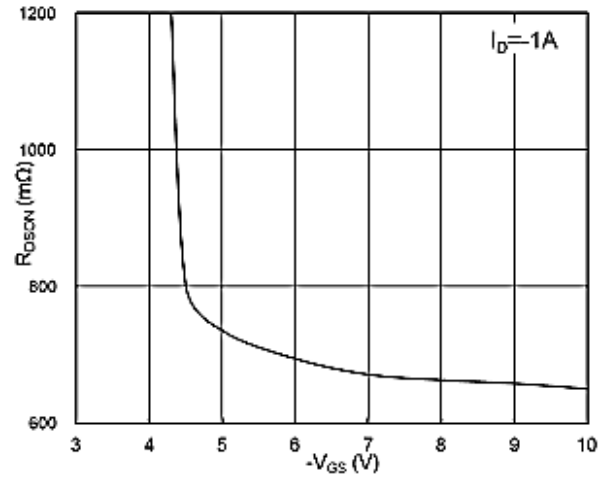

Fig.2 On-Resistance vs G-S Voltage

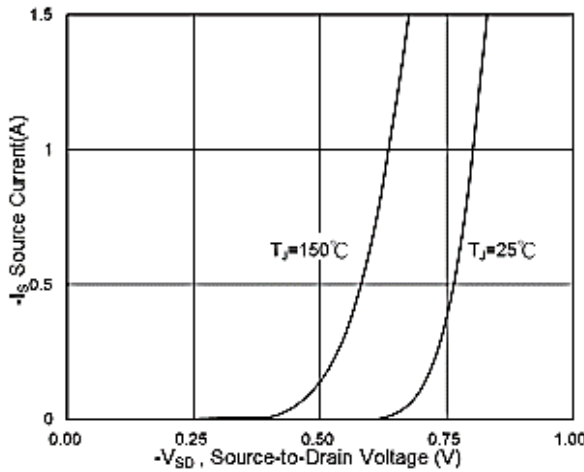

Fig.3 Source Drain Forward Characteristics

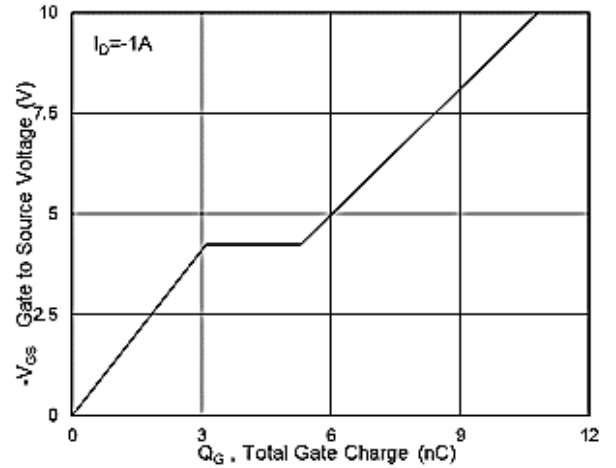

Fig.4 Gate-Charge Characteristics

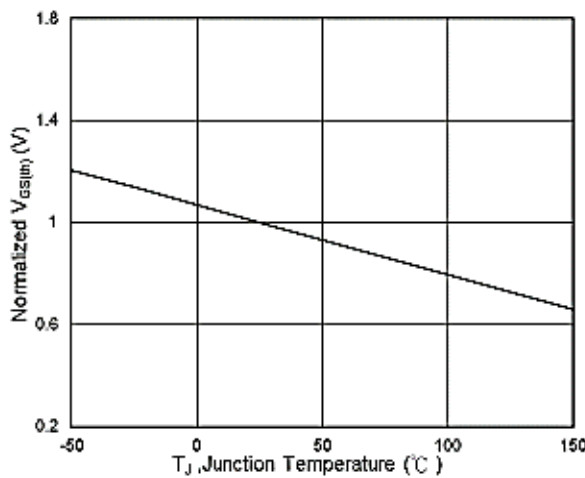

Fig.5 Normalized $V_{GS(th)}$ vs T_J

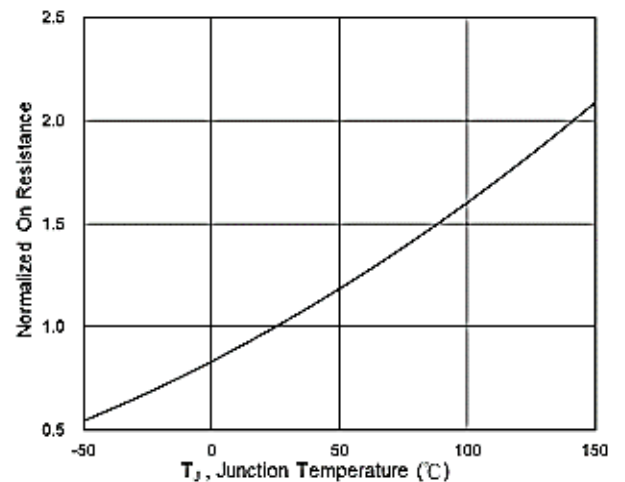

Fig.6 Normalized $R_{DS(on)}$ vs T_J

Ratings and Characteristic Curves

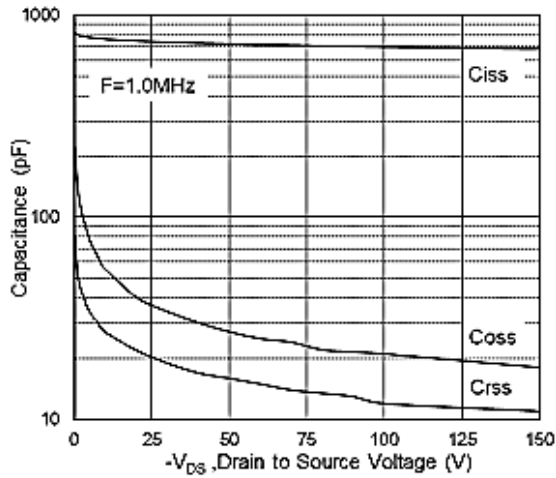

Fig.7 Capacitance

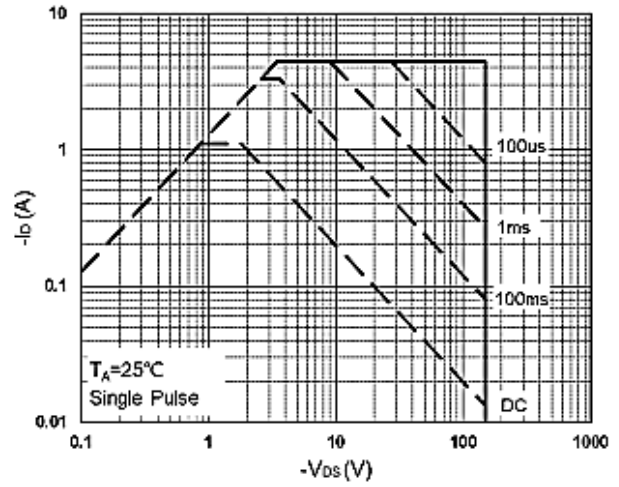

Fig.8 Safe Operating Area

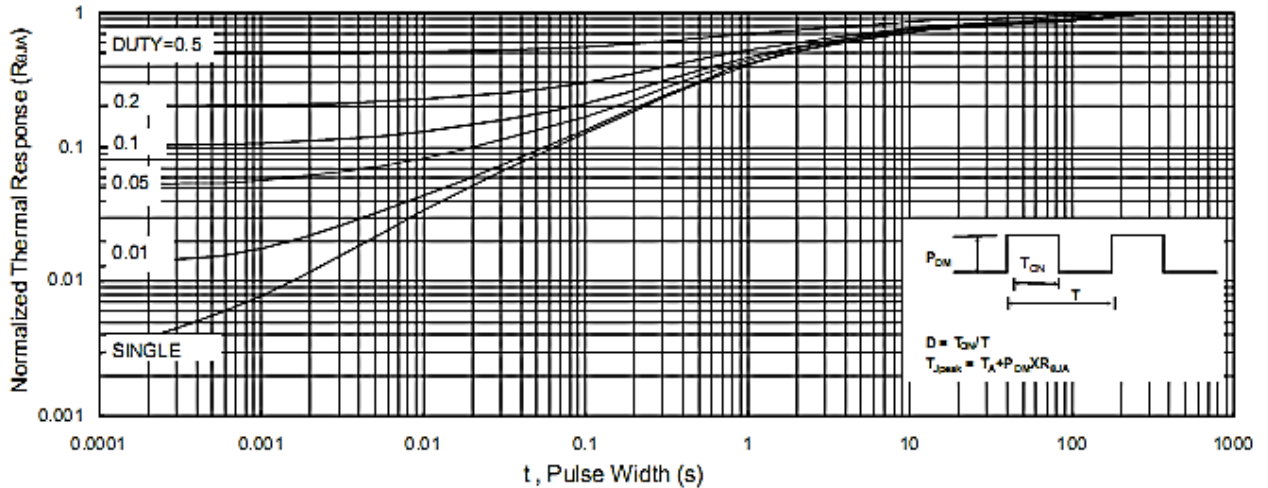

Fig.9 Normalized Maximum Transient Thermal Impedance

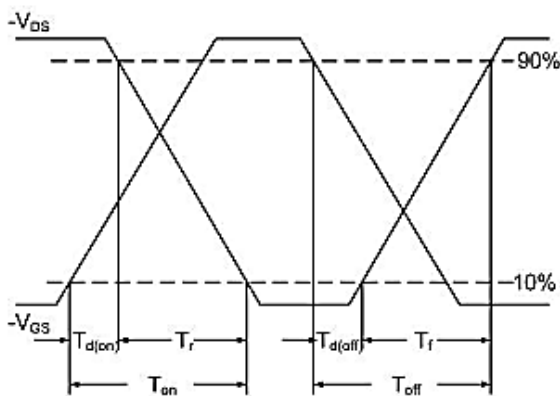

Fig.10 Switching Time Waveform

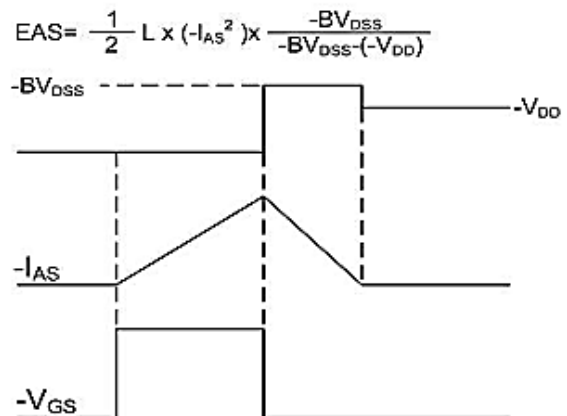
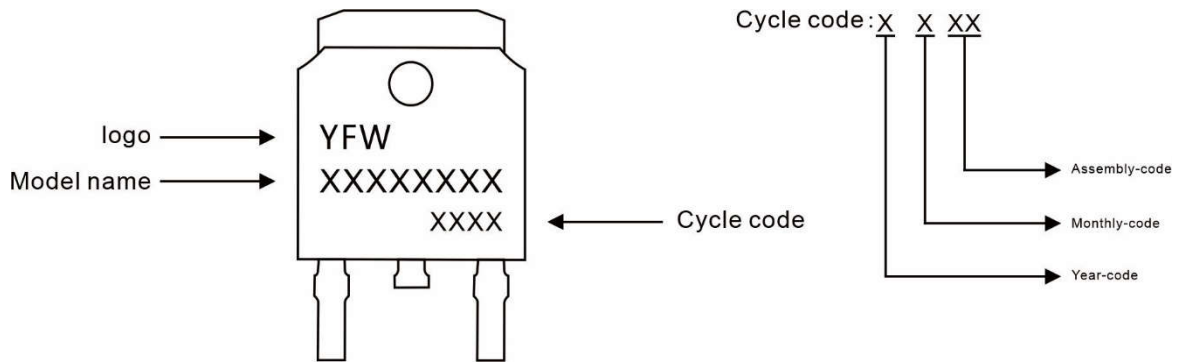

Fig.11 Unclamped Inductive Waveform

Marking Diagram



Ordering information

Model name	Package	Unit Weight	Base Quantity	Packing Quantity
YFW7P15AD	TO-252	0.011oz(0.32g)	2500pcs/reel	5000pcs/box 25000pcs/Carton

Package Dimensions

TO-252

Dim	Millimeter		Inches	
	Min.	Max.	Min.	Max.
A	2.20	2.50	0.087	0.098
A1	0.00	0.12	0.000	0.005
A2	2.20	2.40	0.087	0.094
B	1.20	1.60	0.047	0.063
b	0.50	0.70	0.020	0.028
b1	0.70	0.90	0.028	0.035
c	0.40	0.60	0.016	0.024
c1	0.40	0.60	0.016	0.024
D	6.35	6.65	0.250	0.262
D1	5.20	5.40	0.205	0.213
E	5.40	5.70	0.213	0.224
e	2.20	2.40	0.087	0.094
e1	4.40	4.80	0.173	0.189
L	10.00	11.00	0.393	0.433
L1	2.70	3.10	0.106	0.122
L2	1.40	1.80	0.055	0.071
L3	0.90	1.50	0.035	0.059

Disclaimer

The information presented in this document is for reference only. Guangdong Youfeng Microelectronics Co.,Ltd. reserves the right to make changes without notice for the specification of the products displayed herein to improve reliability, function or design or otherwise. The product listed herein is designed to be used with ordinary electronic equipment or devices, and not designed to be used with equipment or devices which require high level of reliability and the malfunction of which would directly endanger human life (such as medical instruments, transportation equipment, aerospace machinery, nuclear-reactor controllers, fuel controllers and other safety devices), YFW or anyone on its behalf, assumes no responsibility or liability for any damages resulting from such improper use of sale. This publication supersedes & replaces all information previously supplied. For additional information, please visit our website <https://www.yfwdiode.com>, or consult YFW sales office for further assistance.