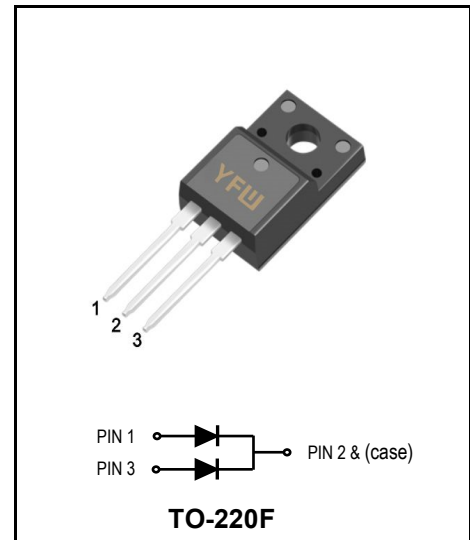

**Super Fast Rectifiers**
**Reverse Voltage - 400V**
**Forward Current - 10A**
**FEATURES**

- Glass passivated chip junctions
- Super fast recovery time for switching mode application
- High Forward Surge Capability
- Low Reverse Current
- Lead free in compliance with EU RoHS 2011/65/EU directive

**MECHANICAL DATA**

- Circuit figure: Common Cathode
- Leads: Solderable per mil-std-202, Method 208
- Polarity: as marked
- Mounting torque: 5 in-lbs maximum
- Terminals: Puretin plated

**MAXIMUM RATINGS AND ELECTRICAL CHARACTERISTICS (TA=25°C)**

| RATINGS  | SYMBOL          | Value      | Units |
|--|-----------------|------------|-------|
| Maximum repetitive reverse voltage   | $V_{RRM}$       | 400        | V     |
| Maximum RMS voltage  | $V_{RMS}$       | 280        | V     |
| Maximum DC blocking voltage  | $V_{DC}$        | 400        | V     |
| Maximum average forward current  | $I_{AV}$        | 10         | A     |
| Peak forward surge current, 8.3ms single half sine-wave superimposed on rated load | $I_{FSM}$       | 150        | A     |
| Typical thermal resistance per diode (Note 1)                                      | $R_{\theta-JC}$ | 4.0        | °C/W  |
| Operation Junction Temperature and Storage Temperature                             | $T_J, T_{STG}$  | -55 ~ +150 | °C    |

**CHARACTERISTICS**

|  |          |          |         |
|--|----------|----------|---------|
| Typical forward voltage per leg at 5A                        | $V_F$    | 1.25     | V       |
| Maximum average reverse current at rated DC blocking voltage | $I_R$    | 5<br>250 | $\mu A$ |
| Typical reverse recovery time (Note 2)                       | $T_{RR}$ | 35       | nS      |

Notes: 1. Thermal resistance from junction to case.  
2. Test conditions:  $I_F=0.5A, I_R=1.0A, I_{RR}=0.25A$ .

**Ratings And Characteristic Curves**

FIG. 1 - TYPICAL FORWARD CURRENT DERATING CURVE

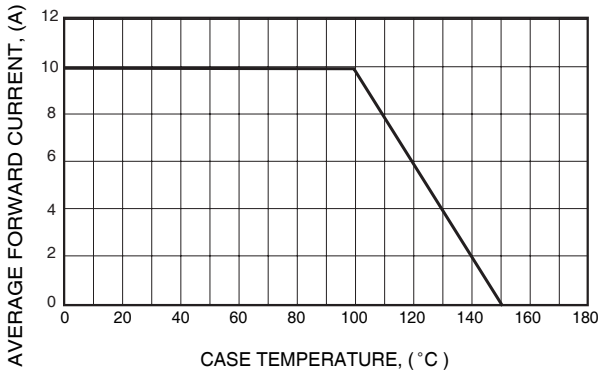

FIG. 3 - MAXIMUM NON-REPETITIVE FORWARD SURGE CURRENT

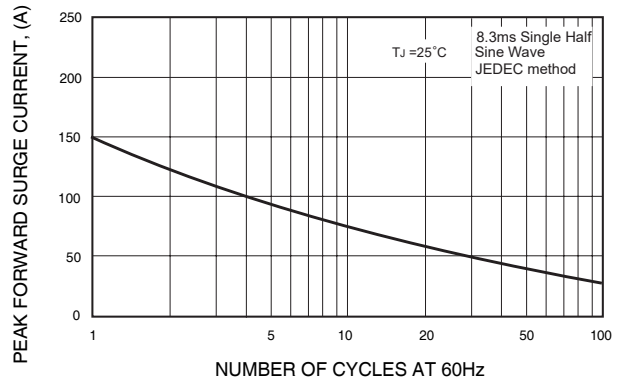

FIG. 4 - TYPICAL REVERSE CHARACTERISTICS

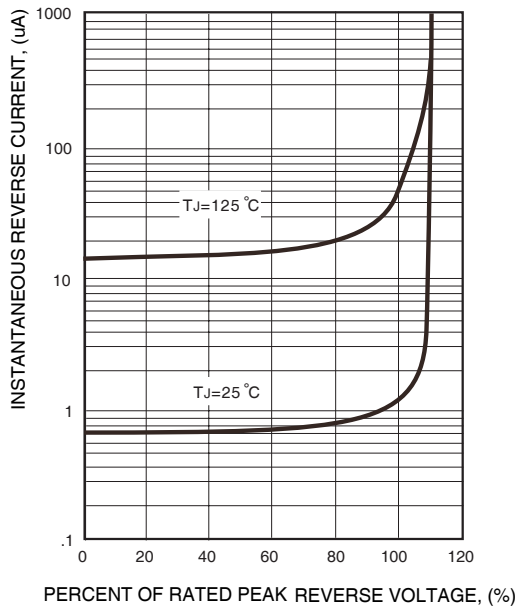

FIG. 2 - TYPICAL INSTANTANEOUS FORWARD CHARACTERISTICS

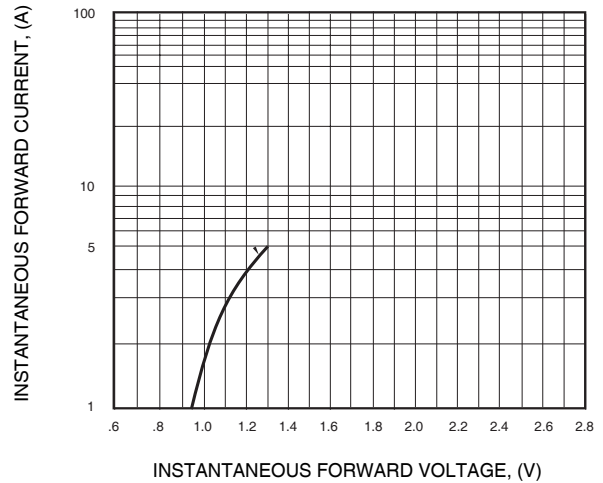
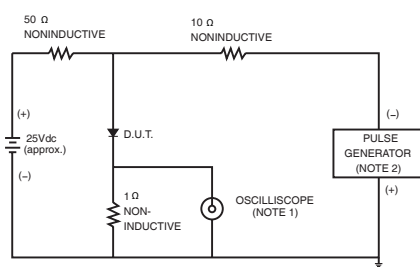
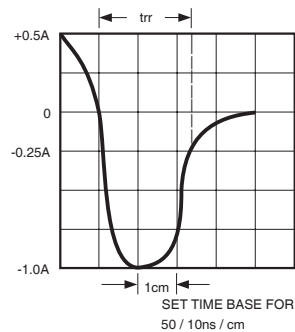

FIG.6- TEST CIRCUIT DIAGRAM AND REVERSE RECOVERY TIME CHARACTERISTICS



NOTES: 1. Rise Time= 7ns max., Input Impedance= 1 megohm.22pF.  
2. Rise Time= 10ns max., Source Impedance= 50 ohms.



**Marking Diagram**

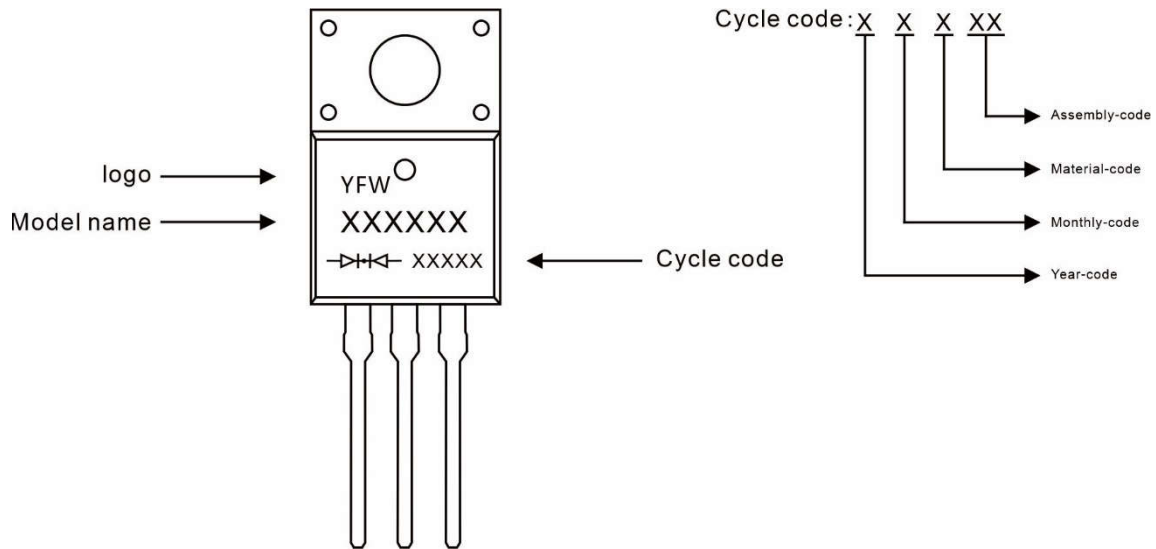

**Ordering information**

| Model name | Package | Unit Weight   | Base Quantity | Packing Quantity           |
|------------|---------|---------------|---------------|----------------------------|
| MUR1040DF  | TO-220F | 0.06oz(1.74g) | 50pcs/tube    | 1000PCS/Box 5000PCS/Carton |

**Package Dimensions**

**TO-220F**

| Symbol | Millimeter |       | Inches |       |
|--------|------------|-------|--------|-------|
|        | Min.       | Max.  | Min.   | Max.  |
| A      | 4.50       | 4.90  | 0.177  | 0.193 |
| A1     | 2.34       | 2.74  | 0.092  | 0.108 |
| A2     | 2.66       | 2.86  | 0.105  | 0.113 |
| b      | 0.75       | 0.85  | 0.030  | 0.033 |
| b1     | 1.24       | 1.44  | 0.049  | 0.057 |
| c      | 0.40       | 0.60  | 0.016  | 0.024 |
| D      | 10.00      | 10.32 | 0.394  | 0.406 |
| E      | 15.75      | 16.05 | 0.620  | 0.632 |
| e      | 2.44       | 2.64  | 0.096  | 0.104 |
| e1     | 4.88       | 5.28  | 0.192  | 0.208 |
| F      | 3.10       | 3.5   | 0.122  | 0.138 |
| L      | 13.50      | 13.90 | 0.531  | 0.547 |
| L1     | 2.90       | 3.30  | 0.114  | 0.130 |
| Φ      | 3.10       | 3.30  | 0.122  | 0.130 |

## Disclaimer

The information presented in this document is for reference only. Guangdong Youfeng Microelectronics Co.,Ltd. reserves the right to make changes without notice for the specification of the products displayed herein to improve reliability, function or design or otherwise. The product listed herein is designed to be used with ordinary electronic equipment or devices, and not designed to be used with equipment or devices which require high level of reliability and the malfunction of which would directly endanger human life (such as medical instruments, transportation equipment, aerospace machinery, nuclear-reactor controllers, fuel controllers and other safety devices), YFW or anyone on its behalf, assumes no responsibility or liability for any damages resulting from such improper use of sale. This publication supersedes & replaces all information previously supplied. For additional information, please visit our website <https://www.yfwdiode.com>, or consult YFW sales office for further assistance.