

2.0A GLASS PASSIVATED BRIDGE RECTIFIER

Reverse Voltage - 100 to 1000 V

Forward Current – 2.0A

FEATURES

- ◆High current capability
- ◆Low forward voltage drop
- ◆Glass Passivated Chip Junction
- ◆Low power loss, high efficiency
- ◆Lead free in comply with EU RoHS 2011/65/EU directives

MECHANICAL DATA

- ◆Case: KBP
- ◆Terminals: Solderable per MIL-STD-202, Method 208
- ◆Approx. Weight: 1.52g / 0.05oz

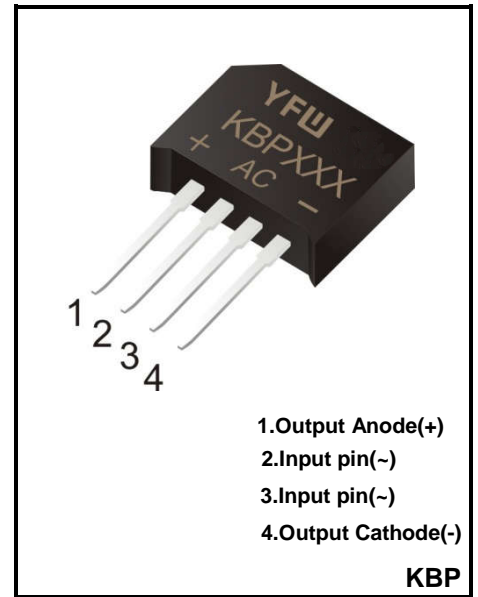

Maximum Ratings and Electrical characteristics

Ratings at 25 °C ambient temperature unless otherwise specified.

Parameter	Symbols	KBP201	KBP202	KBP204	KBP206	KBP208	KBP210	Units
Maximum Repetitive Peak Reverse Voltage	V_{RRM}	100	200	400	600	800	1000	V
Maximum RMS voltage	V_{RMS}	70	140	280	420	560	700	V
Maximum DC Blocking Voltage	V_{DC}	100	200	400	600	800	1000	V
Average Rectified Output Current	$I_{(AV)}$	2						A
Peak Forward Surge Current 8.3 ms Single Half Sine-Wave Superimposed on Rated Load (JEDEC method)	I_{FSM}	60						A
Peak Forward Surge Current @ $T_j = 25\text{ }^\circ\text{C}$ 1.0ms single half sine-wave @ $T_j = 125\text{ }^\circ\text{C}$	I_{FSM}	80 100						A
Forward Voltage per element @ $I_F = 2.0\text{A}$ and $25\text{ }^\circ\text{C}$	V_F	1.1						V
Maximum DC Reverse Current @ $T_j = 25\text{ }^\circ\text{C}$ at Rated DC Blocking Voltage @ $T_j = 125\text{ }^\circ\text{C}$	I_R	5 500						μA
I2t Rating for Fusing($3\text{ms} \leq t \leq 8.3\text{ms}$)	I^2t	17.5						A^2S
Typical Junction Capacitance ^(Note1)	C_j	25						pF
Typical Thermal Resistance ^(Note2)	$R_{\theta JA} / R_{\theta JC}$	40/10						$^\circ\text{C/W}$
Operating and Storage Temperature Range	T_j, T_{stg}	-55 ~ +150						$^\circ\text{C}$

(1) Measured at 1 MHz and applied reverse voltage of 4 V D.C

(2) Thermal Resistance Junction to Case, Lead and Ambient.

Ratings And Characteristic Curves

FIG.1 #FORWARD CURRENT DERATING CURVE

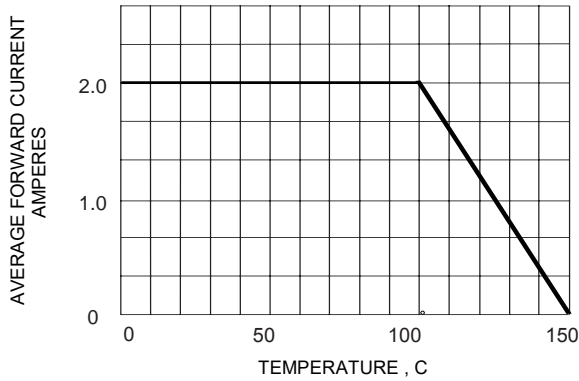

FIG.2 #MAXIMUM NON-REPETITIVE SURGE CURRENT

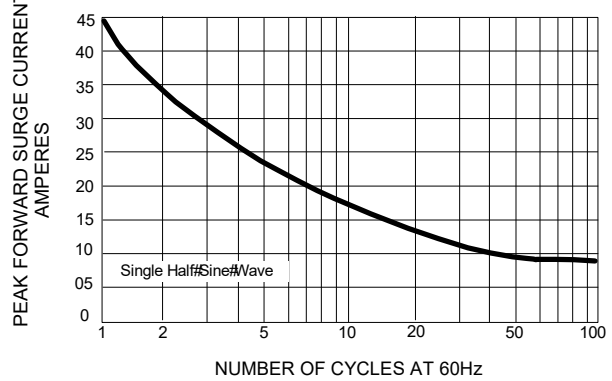

FIG.3 #TYPICAL JUNCTION CAPACITANCE

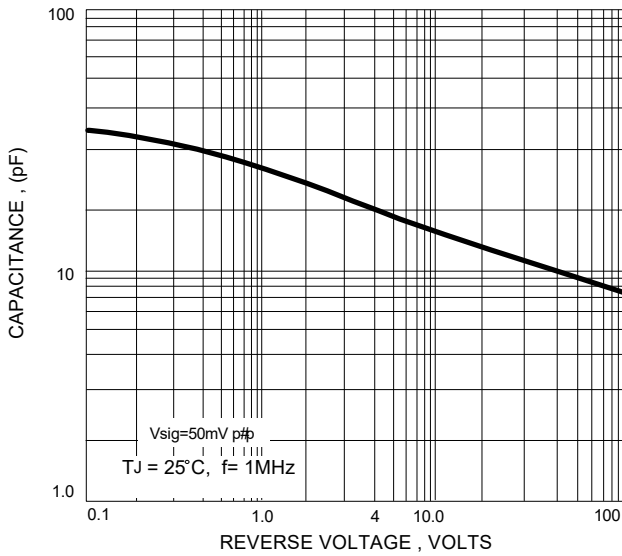

FIG.4 #TYPICAL FORWARD CHARACTERISTICS

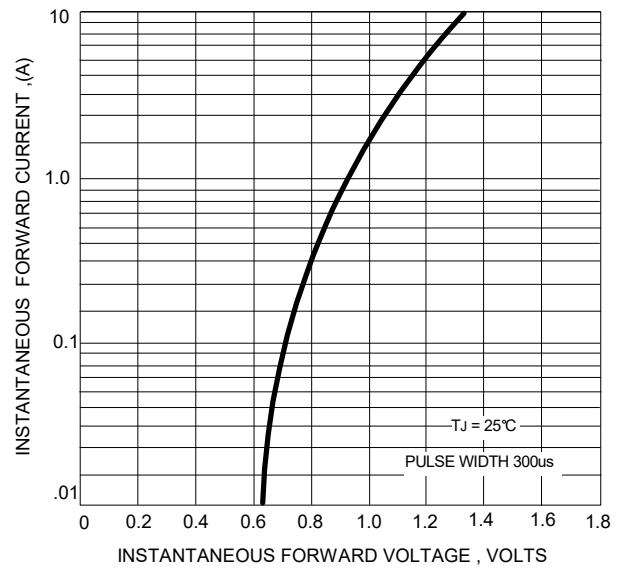
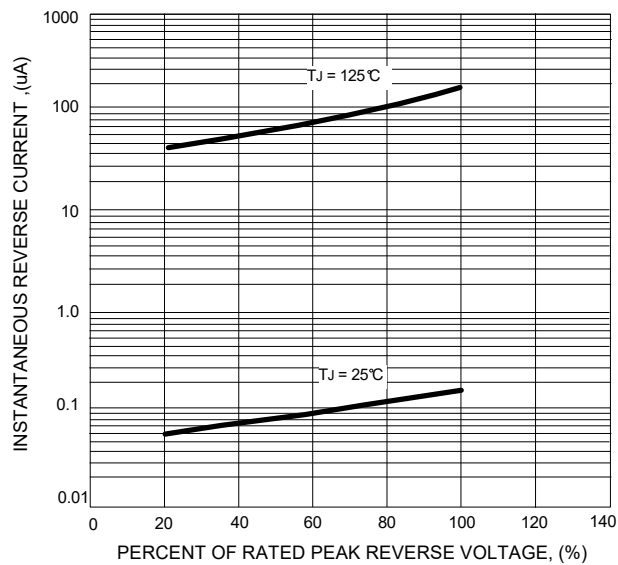
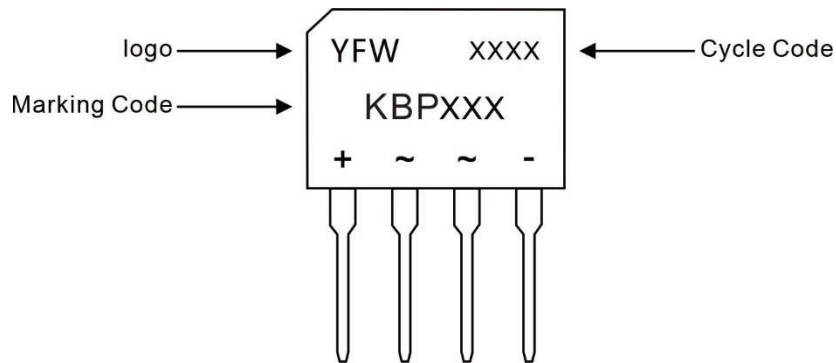

FIG.5 #TYPICAL REVERSE CHARACTERISTICS



Marking Diagram



Ordering information

Package	Packing Description	Packing Quantity
KBP	bulk	500PCS/Box 5000PCS/Carton

Package Dimensions

KBP

Dim.	Millimeter(mm)		Dimensions inInch	
	Min.	Max.	Min.	Max.
A	14.3	14.60	0.56	0.57
B	3.0	3.3	0.12	0.13
c	10.45	10.75	0.41	0.42
D	14.41	14.71	0.57	0.58
d	1.40	1.70	0.06	0.07
E	2.0	2.30	0.09	0.09
F	0.90	1.20	0.04	0.05
G	3.50	3.80	0.14	0.15
H	0.35	0.37	0.01	0.01
I	1.43	1.45	0.06	0.06
J	0.8	0.83	0.03	0.03
K	2.7×45° (Typ)		0.11×45° (Typ)	
L	#	3°	#	3°
M	#	2°	#	2°

Disclaimer

The information presented in this document is for reference only. GuangDong Youfeng Microelectronics Co.,Ltd. reserves the right to make changes without notice for the specification of the products displayed herein to improve reliability, function or design or otherwise. The product listed herein is designed to be used with ordinary electronic equipment or devices, and not designed to be used with equipment or devices which require high level of reliability and the malfunction of which would directly endanger human life (such as medical instruments, transportation equipment, aerospace machinery, nuclear-reactor controllers, fuel controllers and other safety devices), YFW or anyone on its behalf, assumes no responsibility or liability for any damages resulting from such improper use of sale. This publication supersedes & replaces all information previously supplied. For additional information, please visit our website <https://www.yfwdiode.com>, or consult YFW sales office for further assistance.